

# ASFIR<sup>TM</sup>

## 4x4

OFF ROAD MASTERS



## Mitsubishi











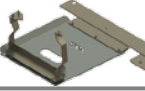

---

## Vehicles

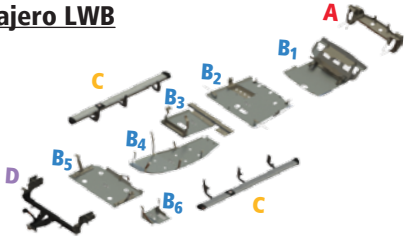

Pajero BK | Triton L-200 | Outlander | Pajero King | Pajero Q | L-200

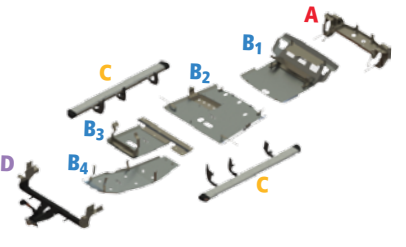
## Pajero BK LWB / SWB

<b>A<sub>1</sub></b>		<b>P/N 503020</b>	Hidden winch mount		
<b>B<sub>1</sub></b>		<b>P/N 503058</b> diesel <b>P/N 503056</b> petrol	Front skid plate		
<b>B<sub>2</sub></b>		<b>P/N 503062</b> diesel <b>P/N 503061</b> petrol	Gear skid plate		
<b>B<sub>3</sub></b>		<b>P/N 503067</b> diesel <b>P/N 503066</b> petrol	Transfer skid plate		
<b>B<sub>4</sub></b>		<b>P/N 503071</b> LWB <b>P/N 503072</b> SWB	Fuel tank skid plate		
<b>B<sub>5</sub></b>		<b>P/N 503079</b> LWB	Rear bench skid plate		
<b>B<sub>6</sub></b>		<b>P/N 503078</b> LWB	Air Condition skid plate	<p><b>Pajero LWB</b></p> 	
<b>C</b>		<b>P/N 501050</b> LWB (Black) <b>P/N 503050</b> SWB (Black) <b>P/N 501054</b> LWB (Silver) <b>P/N 503054</b> SWB (Silver)	Side protectors / steps		<p><b>Pajero SWB</b></p> 
<b>D</b>		<b>P/N 503040</b> LWB <b>P/N 503044</b> SWB	Permanent Tow Bar		
<b>D<sub>1</sub></b>		<b>P/N 503046</b> LWB <b>P/N 503048</b> SWB	Detachable Tow Bar		

\*\*\* For More Products Visit Our Website: [www.asfir.com](http://www.asfir.com) \*\*\*

**Pajero LWB Skid plates**

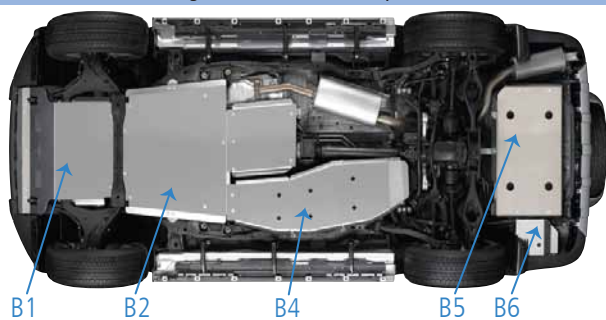

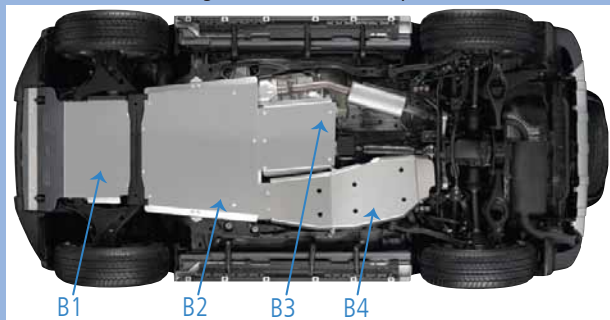

**Pajero SWB Skid plates**



**Hidden winch mount**



## Triton L-200

<b>A</b>		<b>P/N 597111</b>	Tubular Winch Bumper ( installed on the original bumper)	
<b>A1</b>		<b>P/N 597182</b> <b>P/N 597112</b>	Front Bumper Tubular protector 2010+ Front Bumper Tubular protector 06-09	
<b>B1</b>		<b>P/N 597158</b>	Front skid plate - Diesel 06-12	
<b>B2</b>		<b>P/N 597162</b> auto' 2012 (DPP) <b>P/N 597161</b> manual 06-11 <b>P/N 597160</b> auto' 06	Gear / Transfer skid plate - Diesel	
<b>B3</b>		<b>P/N 597170</b>	Fuel tank skid plate - Diesel 06-12	
<b>C</b>		<b>P/N 597154</b> (Black) <b>P/N 597153</b> (Silver)	Side protector incl. side step Diesel 06-12	
<b>D</b>		▪ <b>P/N 583029</b> ▪ <b>P/N 597191</b> <b>P/N 583025</b>	HDA tow bumper (shown in picture) HDN tow bumper *TUV approved HD tow bumper	
<b>E</b>		<b>P/N 597185</b> 10-12	Utility Rack	
<b>*** For More Products Visit Our Website: <a href="http://www.asfir.com">www.asfir.com</a> ***</b>				

\* Products tested and approved by **TUV 94/20/EC**









### Triton L-200 Skid plates

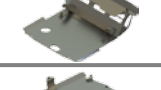
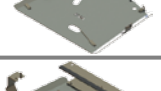

## Outlander

<b>B1</b>		<b>P/N 598156</b> Petrol 2.4L auto 07-12 <b>P/N 598155</b> Petrol auto 06 <b>P/N 598158</b> Diesel 2.0L manual 07-08	Front skid plate	
<b>B2</b>		<b>P/N 598070</b> 2L diesel man. 07-10 / 2.4L petrol auto 08-12	Fuel tank skid plate right + left	
<b>B3</b>		<b>P/N 598170</b> Diesel man. 07-12	Fuel tank radiator skid plate	
<b>B4</b>		<b>P/N 598100</b> 2L diesel manual 07-10 / 2.4L petrol auto 07-12	Rear differential skid plate	
<b>C</b>		<b>P/N 598150</b> 10-12	Side Step	
<b>D</b>		<b>P/N 598143</b> Diesel (VW2L) manual / Petrol (M2.4L) auto' 08-12	Detachable tow bar (incl. control box)	
		<b>P/N 598140</b> Petrol auto' 06-07	Permanent rear tow bar	
<b>*** For More Products Visit Our Website: <a href="http://www.asfir.com">www.asfir.com</a> ***</b>				

## Pajero CK Model 2001-2006

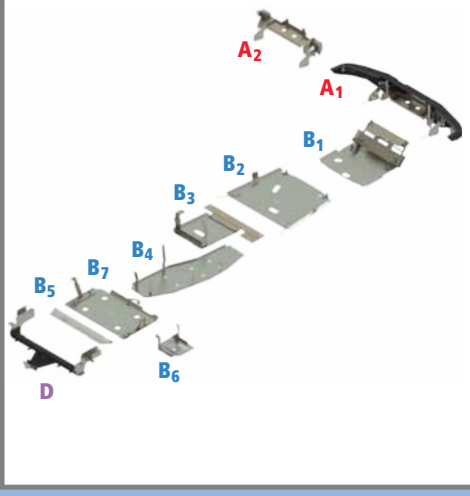
<b>A1</b>		<b>P/N 502002</b> 01-06	ATL winch bumper	
<b>A2</b>		<b>P/N 567020</b> 03	Hidden winch mount	
<b>B1</b>		<b>P/N 502055</b> 01-02 <b>P/N 502056</b> 03-06	Front skid plate	
<b>B2</b>		<b>P/N 502060</b> diesel auto' 01-06 <b>P/N 502061</b> diesel man. 01-06	Gear skid plate	
<b>B3</b>		<b>P/N 502065</b> diesel auto' 01-06 <b>P/N 502066</b> diesel man. 01-06	Transfer skid plate	
<b>B4</b>		<b>P/N 502070</b> LWB 01-06 <b>P/N 502071</b> SWB 01-06	Fuel tank skid plate	
<b>B5</b>		<b>P/N 502076</b> 01-02	Rear bumper skid plate	
<b>B6</b>		<b>P/N 503078</b> LWB diesel auto' 01-12	Air condition skid plate	
<b>B7</b>		<b>P/N 503079</b> LWB 01-12	Rear bench skid plate	
<b>D</b>		<b>P/N 502043</b> LWB 01-06 <b>P/N 502044</b> SWB 01-06	Permanent Tow Bar	
<b>*** For More Products Visit Our Website: <a href="http://www.asfir.com">www.asfir.com</a> ***</b>				

## Pajero Q

<b>A1</b>		<b>P/N 501001</b> *GLX 97-00 <b>P/N 501002</b> GLS 94-99 <b>P/N 501003</b> GLS 99-00	ATL Winch bumper * with flares	
<b>A2</b>		<b>P/N 501020</b> SWB 92-00	Hidden winch mount	
<b>B1</b>		<b>P/N 501055</b> 92-00	Front skid plate	
<b>B2</b>		<b>P/N 501060</b> man. diesel 92-00 auto. SWB petrol 92-95	Transfer skid plate	
<b>B3</b>		<b>P/N 501061</b> auto' LWB diesel 92-00	Gear skid plate	
<b>B4</b>		<b>P/N 501070</b> SWB 92-00 <b>P/N 501072</b> LWB 92-00	Fuel tank skid plate	
<b>*** For More Products Visit Our Website: <a href="http://www.asfir.com">www.asfir.com</a> ***</b>				

## L-200

<b>A</b>		<b>P/N 500002</b> 02-05 <b>P/N 500001</b> 97-01	ATL winch bumper	
<b>B1</b>		<b>P/N 500056</b> 02-06 <b>P/N 500055</b> 98-01	Front skid plate	
<b>B2</b>		<b>P/N 500060</b> man. 98-01 <b>P/N 500061</b> auto' 98-01	Gear skid plate	
<b>B3</b>		<b>P/N 500065</b> man. 98-06	Transfer skid plate	
<b>B4</b>		<b>P/N 500070</b> 98-05	Fuel tank skid plate	
<b>D</b>		<b>P/N 583026</b>	HDN tow bumper (shown in picture)	
		<b>P/N 583025</b>	HD tow bumper	
		<b>P/N 583029</b>	HDA detachable tow bumper	
<b>*** For More Products Visit Our Website: <a href="http://www.asfir.com">www.asfir.com</a> ***</b>				

## Professional Quality Products

Asfir's variety of products is the perfect solution for accessorizing the off-road vehicle.

### ATL Winch Bumper

The innovative ATL winch bumper is designed and developed to replace the original bumper. The bumper covers the winch, but is not attached to it. It has many openings to ventilate the vehicle and enables easy access to the winch for maintenance.

ATL bumpers are characterized in low weight and in keeping close proximity to the vehicle's original contour lines.

### Side Protectors

Protect the lower side of the vehicle and aid recovery with a jack. The side protectors are made of quality metal combined with aluminum side steps.

### Skid Plates

Quality skid plates for off road vehicles have one of the highest design, performance and finish standards in the world.

Asfir offers various skid plates protecting the underbody parts of the vehicle such as front, gear, transfer and fuel tank.

The skid plates are made of quality aluminum and are screwed to original holes in the vehicle. Service openings in the skid plates enable servicing the vehicle without dismantling the plates.

### Rear Towing Device

Asfir's towing device mounts to the vehicle's chassis, under the original bumper.

### 4x4 Accessories

Asfir has a wide variety of accessories such as recovery kits, compressors, Hi Lift jacks, recovery straps, shackles, pulley blocks and ratchets.



**ASFIR**  
**4x4**

3.2013

QUALITY 4x4 ACCESSORIES

**ASFIR LTD**  
Tel Adashim 19315, **Israel**  
Telephone: +972-4-6511400  
1-599-599-499\*  
Fax: +972-4-6527742  
E mail: [info@asfir.com](mailto:info@asfir.com)  
[www.asfir.com](http://www.asfir.com)  
\* (Israel only)



Distributed by :

