

72-06 CJ, YJ, TJ, LJ HOOD LIFT

Contents:

	QTY.
1. Hood Lift Strut	(2)
2. Lower Rod	(2)
3. Upper Sleeve	(2)
4. L Bracket	(2)
5. Lower Ball Stud Mount	(2)
6. U-Bolt Clamp	(2)
7. 5/16" Ball Stud	(4)
8. 5/16" Nylock Nut	(4)
9. 1/4"-20 Hex Bolt	(2)
10. 1/4"-20 Nylock Nut	(2)
11. 1/4" Flat Washer	(4)
12. #14 Sheet Metal Screw	(12)
13. #14 Lock Washer	(12)

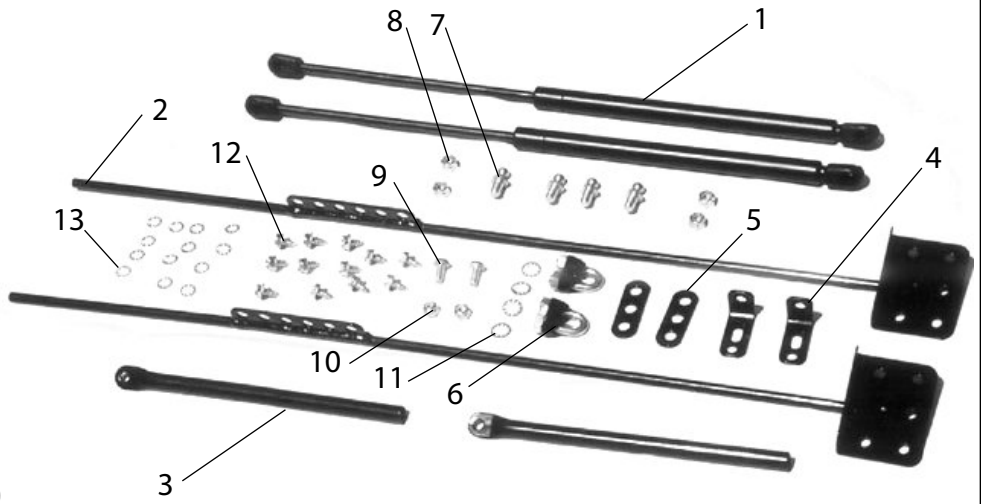

1. Install L brackets to underside of hood. See directions below for your specific vehicle.
NOTICE: WHENEVER DRILLING IS REQUIRED, ONLY DRILL INTO SHEET METAL BRACING ON UNDERSIDE OF HOOD. BEFORE DRILLING, WRAP MASKING TAPE AROUND DRILL BIT 1.8" FROM THE TIP. DO NOT DRILL DEEPER THAN THE TAPE TO AVOID DIMPLING OR DAMAGING YOUR HOOD.

TJ/LJ

Remove factory prop rod bracket on passenger side under hood and install an L bracket in its place reusing the factory hardware as shown. Measure the location of the installed L bracket and use the dimensions to mark and drill for the driver side L bracket. Use a 5/64" bit. Do not overtighten sheet metal screws.

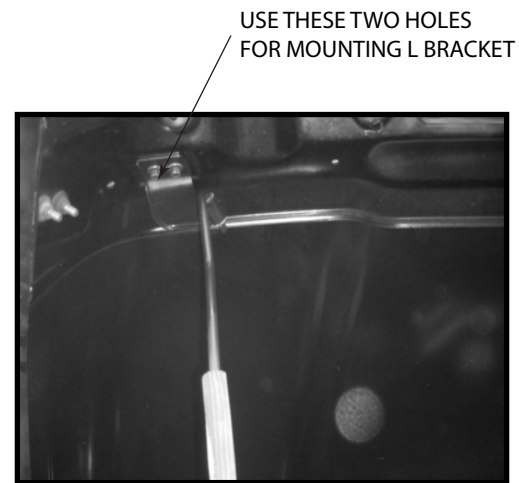

YJ

Drill both holes on the passenger side under the hood. Measure approx 6" from the edge of the hood and mark holes on front hood cross bracing using the L bracket as a guide. Drill holes to 5/64". Measure the location of the installed L bracket and use the dimensions to mark and drill for the driver side L bracket. Do not overtighten sheet metal screws.

MOUNT L BRACKET APPROX 6" FROM EDGE OF HOOD ON FRONT HOOD BRACE

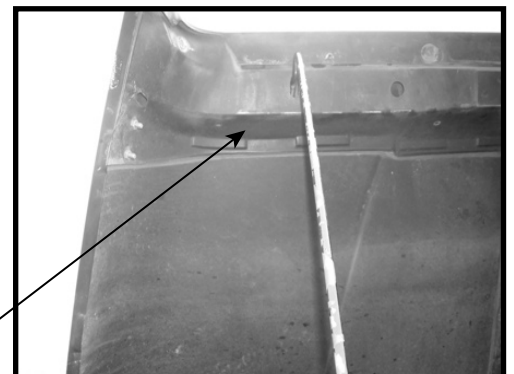

72-06 CJ, YJ, TJ, LJ HOOD LIFT

CJ
Remove factory prop rod on passenger side under hood. Use the outermost hole to mount the L bracket. Mark and drill the second mounting hole to 5/64" using the L bracket as a guide. This hole should be to the left of the first hole. Insert a nut and washer in the obround cutout to retain the bolt. Measure the location of the installed L bracket and use the dimensions to mark and drill for the driver side L bracket. Do not overtighten sheet metal screws.

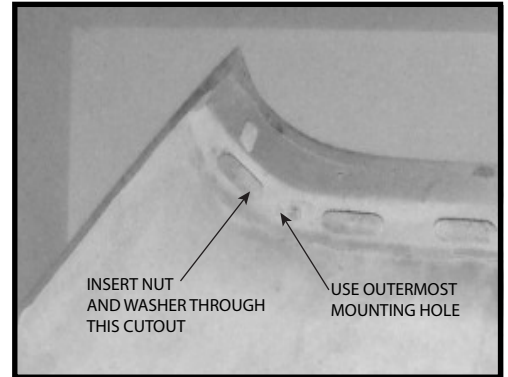

2. Locate the cross brace on the rear underside of the hood. Place lower rod on rear hood cross brace no less than 1 inch outbound of the radiator brace rod as shown. Mark holes in the bracket for mounting. It is not necessary to use all of the holes provided. Some holes may fall on cutouts and be unusable. You should be able to use at least 6 holes for each bracket including the holes on the top flange. Drill holes using a 5/64" bit being sure not to drill too deep. Secure with supplied sheet metal screws. NOTICE: SHEET METAL SCREWS ARE EASILY STRIPPED. BE NOT TO OVERTIGHTEN.



3. Slide lower rod installed in step 2 into upper sleeve. Bolt upper sleeve to L bracket mounted to hood in step 1. Use 1/4"-20 bolt with flat washers and Nylock nut as shown.



4. Bolt the lower ball stud mounting plate to the radiator brace rod about 6" from the fire wall using the supplied U-bolt. Orient the plate such that the unused hole is located above the rod. Insert a ball stud into the unused hole and tighten using a Nylock nut and washer. The ball should face outward as shown. Do this for both radiator brace rods.

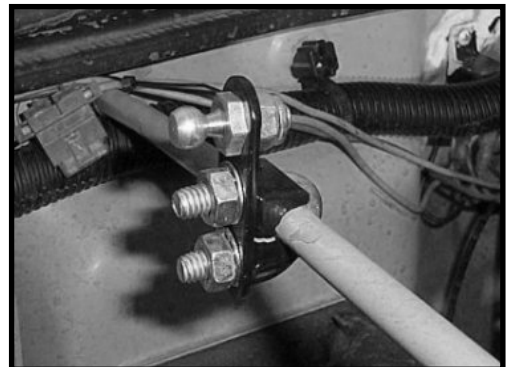

72-06 CJ, YJ, TJ, LJ HOOD LIFT

5. Insert ball stud in one of the six holes on the plate welded to the lower rod installed in step 2. Using the bottom hole will provide maximum lift while using the top hole will provide minimum lift. Be sure to use the same hole for each ball stud. Clip gas strut onto the mounted ball studs. Clip the body of the gas strut to the upper ball stud as shown.



6. Make sure all hardware is tightened. Slowly lower hood while looking underneath to make sure no interference occurs. There may be a clearance issue in TJ/LJ models with the washer fluid reservoir. This can usually be fixed by grinding down the web between the cap and the hump in the reservoir.

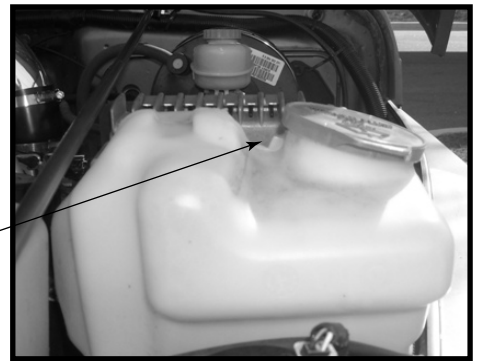

GRINDING THIS WEB MAY BE NECESSARY TO AVOID INTERFERENCE

7. Installation is now complete. No more annoying prop rod in the way when working under the hood!

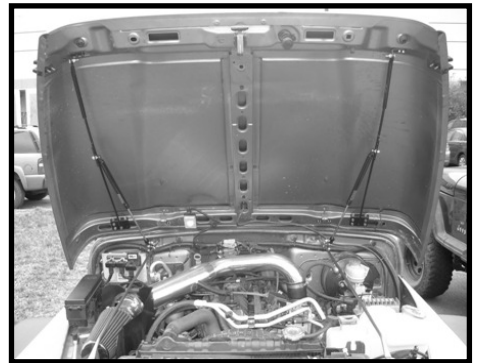

OMIX-ADA® LIMITED WARRANTY

Your Omix-Ada® product is covered by the Limited Warranty explained below that gives you specific legal rights. This limited warranty is the only warranty Omix-Ada® makes in connection with your product purchase. Parts sold by Omix-Ada® but supplied by other vendors are exclusively warranted by the vendor supplying the part. Omix-Ada® neither assumes nor authorizes any vendor, retailer or other person or entity to assume for it any other obligation or liability in connection with this product or limited warranty.

What is covered? Subject to the terms, exclusions and limitations herein and with respect only to products first sold in the United States, Omix-Ada® warrants to the initial retail purchaser only that its branded parts (including Rugged Ridge™ and Outland™ products) shall be free of defects in material and workmanship for a period of six (6) months or 6000 miles from date of initial purchase. Your warrantor for these parts is Omix-Ada®, Inc., 460 Horizon Dr., Suite 400 Suwanee, GA 30024. Omix-Ada® reserves the right to require proof of purchase as a condition of this Limited Warranty.

What is not covered. Your Omix-Ada® limited warranty does not cover electrical components or body parts which are sold "AS IS" due to possible damage through installation or shipping. Your Omix-Ada® limited warranty further does not cover products or parts supplied to Omix-Ada® by outside vendors or products, parts or vehicles Omix-Ada® determines to have been damaged by or subjected to:

- Installation damage, alteration, modification or failure to maintain
- Normal wear and tear (bushings, tie-rod ends, etc.)
- Scratches or defects in product finishes (powder coating, plating, etc.) or damage due to shipping
- Damage arising or related to non-Omix-Ada® parts, including but not limited to any vehicle's electronic stability system, related components or other vehicle systems
- Racing or other vehicle competitions or contests
- Accidents, impact by rocks, trees, obstacles or other aspects of the environment
- Theft, vandalism or other intentional damage

Remedy Limited to Repair / Replacement. The exclusive remedy provided hereunder shall, upon Omix-Ada® inspection and at Omix-Ada®'s option, be either repair or replacement of product or parts covered under this Limited Warranty. Customers requesting warranty consideration on Omix-Ada® branded parts (including Rugged Ridge™ and Outland™) should first contact the independent distributor from whom you purchased your part to obtain a Returned Goods Authorization number. All removal, shipping and installation costs are customer's responsibility. Customers requesting warranty consideration on non-Omix-Ada® branded parts should refer to the manufacturers' Limited Warranty and contact them directly. If a replacement part is needed before the Omix-Ada® part can be returned, you must first purchase the replacement part. Then, if Omix-Ada® deems the part warrantable, you will be credited the purchase price.

Other Limitations - Exclusion of Damages - Your Rights Under State Law

- In consideration of the purchase price paid, neither Omix-Ada® nor any independent Omix-Ada® distributor/licensee are responsible for any time loss, rental costs, or for any incidental, consequential, punitive or other damages you may have or incur in connection with any part or product purchased. *Your exclusive remedy hereunder for covered parts is repair/replacement as described above.*
- This Limited Warranty gives you specific rights. You may also have other rights that vary from state to state. For example, While all implied warranties are disclaimed herein, any implied warranty required by law is limited to the terms of our Limited Lifetime Warranty as described above. *Some states do not allow limitations of how long an implied warranty lasts and /or do not allow the exclusion or limitation of incidental or consequential damage, so the limitations and exclusions herein may not apply to you.*